



START HERE

To install your LED Driver Feedback Signs

Your guide to install and maintain most components including...

- **9" Portable Value Driver Feedback Sign**

Contents

BABA - ISO 9001:2015	2
1 About this Manual	3
1.1 Purpose of Manual	3
1.2 Manual Conventions	3
1.3 Related Document	3
1.4 Manual Organization	3
2 Safety Information	4
2.1 Intended Use	4
2.2 Technical Support	4
2.3 Safety Messages	4
2.3.1 Safety Message Format	4
2.4 Safety Messages Contained in This Manual	4
2.5 Safety Considerations	6
2.5.1 Personal Safety Equipment and Clothing	6
2.5.2 Electrical Shock	6
2.5.3 RF Exposure	6
2.5.4 Battery Safety	6
2.5.6 Functional Safety	8
3 Description	8
3.1 9SE DFB Sign Specifications	10
3.2 9SE DFB Sign Power Kit	10
4 Pre-Installation	10
4.1 Site Survey	11
4.2 Pole Selection	11
4.3 Mounting Bracket	11
4.4 Sign Test Procedure	11
4.4.1 Expected Sign Behavior	12
4.4.2 Expected Charging Behavior	12
5 Installation	12
5.1 Sign Installation	12
5.1.1 Aiming the Sign	13
5.1.2 Sign Radar Operation	13
5.1.3 Radar Properties	14
5.1.4 Measurement Angle	14
5.2 Powering on and Programming Sign	16
5.2.1 Powering on and Programming Sign	17
5.2.2 Speed Settings	17
5.2.3 Squelch Adjustment	17
5.2.4 Setting Units	17
5.2.5 Setting Brightness Adjustment	17
5.2.6 Setting Start-Up Option	17
5.2.7 Setting a Security Passkey	17
5.2.8 Programming Timed Operation	18
5.2.9 Display Test and Demo	18
6 Troubleshooting	19
6.1 General Troubleshooting	20
Warranty	23
Appendix A: 9SE DFB Drawing	24
Appendix C: Status LED Key	25
REVISION BLOCK	27

Build America, Buy America Compliant



At TraffiCalm, we take immense pride in contributing to the development and improvement of America's roadways. Our commitment to the "Build America, Buy America" initiative is unwavering. We're pleased to share that our Radar Speed Signs, Flashing Sign Systems, and Intelligent Warning Systems are not only manufactured in the United States but are also constructed from materials produced substantially within our great nation.

For those seeking further information, services, or inquiries regarding our American-made traffic safety solutions, please do not hesitate to contact us. We're here to support your initiatives and help make America's roadways safer for all.

Thank you for choosing TraffiCalm as your trusted partner in enhancing transportation safety across the United States.

ISO 9001: QUALITY STANDARDS



ISO 9001 certification signifies TraffiCalm's unwavering commitment to exceptional quality and continual improvement.

It reflects our dedication to delivering outstanding products and services, ensuring customer satisfaction and operational excellence. Our certification is a mark of reliability and consistency, demonstrating our commitment to excellence in the traffic safety industry.

1 About this Manual

1.1 Purpose of Manual

This manual provides the installation and setup instructions for the TrafficCalm 9SE LED Driver Feedback Sign. This manual is intended for use by installers, maintenance personnel, and others who are responsible for the installation and maintenance of the driver feedback signs.

1.2 Manual Conventions

The conventions listed in Table 1-1 help to make this manual easier to use by presenting a uniform approach to the descriptions, phrases, and nomenclature.

1.3 Related Document

Other documents pertaining to Driver Feedback Signs (DFB) the supplemental installation guides for the solar and battery options not listed in this manual.

1.4 Manual Organization

This manual is divided into seven sections and two appendixes.

Section 1. About This Manual

Contains information about the organization and content of this manual.

Section 2. Safety Information

Contains important information about the safety messages, safety considerations, and procedures for installing this equipment.

Section 3. Description

Describes the driver feedback sign and related accessories.

Section 4. Installation Requirements

Describes the components, tools, and information you must have available before installing a DFB.

Section 5. Pre-Installation

Describes tests used to verify that all of the sign's electrical components are functioning properly prior to installation.

Section 6. Installation

Describes system installation, startup, and operation for the 9SE DFB.

Section 7. Troubleshooting

Contains general troubleshooting information for all DFB signs.

Appendix A. 9SE DFB Drawing

Contains a drawing for the 18x24 inch driver feedback sign model.

Appendix B. Recommended External Beacon Wiring

Contains recommended external beacon wiring drawings.

Table 1-1. Manual Conventions

Element	Convention	Example
Acronyms	Uppercase	LED
Abbreviations	Lowercase ...except where standard Usage is uppercase	ms (milliseconds) Mb (megabits) MB (megabytes)
Model names	First or formal reference; initial caps	TrafficCalm 9SE Driver Feedback Sign
	Subsequent use or informal reference:	Driver feedback sign, DFB or sign

2 Safety Information

We provide important safety information and warnings to assist you in understanding and avoiding potential harm to yourself, and possible damage to equipment during the installation of the Driver Feedback Sign. Although we have included many potential hazards you may encounter during the installation of this equipment, we cannot predict all of the possible hazards and this list should not be a substitute for your judgment and experience.

Please read and observe all safety information and instructions in this manual before installing the system equipment. Also, save this installation manual for future reference.

If you are unsure about any part of this installation or of the potential hazards discussed, please contact your supervisor immediately.

2.1 Intended Use

Driver feedback signs are intended to be used as a traffic calming tool, informing motorists of their actual speed in real-time.

2.2 Technical Support

If you have questions about the system, its use, or operation, please contact your local partner or call the TrafficCalm Technical Service department at 1-855-738-2722, in the U.S.A. Technical service hours: Monday through Thursday, 7:00 AM to 5:00 PM and Friday from 7:00 AM to 12:00 PM Pacific Standard Time.

2.3 Safety Messages

We include safety messages in this manual to help you protect your safety and the safety of others. This section contains important information to help you recognize and understand these safety messages.

Please read all messages before proceeding with the installation of this equipment.

2.3.1 Safety Message Format

Safety messages are designed to alert you to potential hazards that can cause personal injury to you or others. They can also indicate the possibility of property damage.



Each safety message box contains the safety alert symbol ; and one of three signal words:

DANGER, WARNING, or CAUTION; plus a safety message.

The signal words and symbols, and their meanings, are shown below:

 DANGER
The safety message is in this box.

DANGER indicates a potentially hazardous situation, which, if not avoided, will result in death or serious injury and/or property damage.

 WARNING
The safety message is in this box.
WARNING indicates a potentially hazardous situation, which, if not avoided, could result in death or serious injury and/or property damage.
 CAUTION
The safety message is in this box.

CAUTION indicates a potentially hazardous situation, which, if not avoided, may result in minor or moderate injury and/or property damage.

In addition to the symbols and words explained above, each safety message identifies the hazard, describes what you can and should do to avoid the risk of exposure to the hazard, and tells the probable consequences of not avoiding the hazard.

2.4 Safety Messages Contained in This Manual

The following safety messages appear in this manual:

 WARNING
To reduce the risk associated with electric shock injury resulting from contacting high-voltage AC.
-Turn OFF power before connecting wiring to the AC source

9" Portable Value Driver Feedback Sign Installation Instructions

 **WARNING**

To reduce the risk of electric shock related injury resulting from contacting hazardous AC voltage:

- **Portions of this equipment derive power from sources that have high voltage levels. These must be serviced by qualified personnel, who have previous training or certification to safely work on high voltage equipment.**
- Consult a Qualified Electrician.**

 **WARNING**

Battery acid may cause skin irritation and eye injury. **To reduce the risk of burns or other acid related injury resulting from handling lead-acid batteries:**

- Wear gloves, goggles, and an apron when handling batteries
- Beware of cracked battery cases
- Handle batteries with care.

 **WARNING**

To reduce the risk of burns or other acid-related injury resulting from exploding batteries:

- Always use the recommended charging systems with this product.**

 **WARNING**

To reduce the risk associated with contamination of water supplies resulting from improper disposal of batteries containing lead and acid:

- Please dispose of batteries in accordance with all local government laws and regulations.**

 **CAUTION**

Radar RF energy can be harmful to the eyes. **To reduce exposure to the risk of RF energy, do not stare into the radar antenna. Keep a minimum safe distance of 20cm (8-inches) from display face.**

IMPORTANT

Cleaning screen surfaces with solvents may damage the screening ink.

 **CAUTION**

An accidental short circuit may instantly heat conductive jewelry, tools, and surrounding objects to skin-searing temperatures.

To reduce this risk when working around batteries:

- Keep tools, jewelry, and other conductive objects away from the battery terminals.**

 **WARNING**

To reduce the risk of impact hazards resulting from falls, accident with a passing vehicle, and/or from unstable equipment:

- Use appropriate work zone traffic control methods, equipment, and procedures.**

 **CAUTION**

Strain or back injury may result from lifting equipment improperly. **To reduce the risk of strain or back injury, use proper lifting techniques and have adequate help.**

 **CAUTION**

To avoid the possibility of injury due to falling or unstable equipment:

- Be certain the sign is mounted to an appropriately rated pole or equivalent mounting surface.**
- Use appropriately rated mounting hardware.**



 **WARNING**

Pinch Points.
Moving part can crush or cut.
KEEP CLEAR.

2.5 Safety Considerations

Please consider the following safety issues before servicing TrafficCalm Driver Feedback Signs.

Although we have compiled this list of common safety considerations, it should not be considered as complete. It is not intended to take the place of your good judgment, training, and experience. Choose the right equipment for the job. If you are unsure of which safety equipment is recommended or appropriate for the job, ask your supervisor or foreman.

2.5.1 Personal Safety Equipment and Clothing

Personal safety equipment and clothing including high visibility vests, hard hats, gloves, electrical shock or electrocution protection clothing and equipment, safety shoes, safety glasses, face shields, goggles, and hearing protection devices are just some of the items available to you.

2.5.2 Electrical Shock

As a trained installer of electrical equipment you are aware of the dangers associated with servicing electrical devices. Always be sure that the power to the equipment, and all associated equipment, is turned off before beginning any procedure. Use the equipment, techniques, and procedures that you learned during your training or apprenticeship or other electrical industry recognized safety procedures.

DANGER

To reduce the risk associated with electric shock injury resulting from contacting high-voltage AC.
-Turn OFF power before connecting wiring to the AC source.

DANGER

To reduce the risk of electric shock related injury resulting from contacting hazardous AC voltage:

-Portions of this equipment derive power from sources that have high voltage levels. These must be serviced by qualified personnel, have previous training or certification to safely work on high voltage equipment.

Consult a Qualified Electrician.

2.5.3 RF Exposure

This product uses devices that radiate RF energy in the course of normal operation. Always maintain a safe working distance from the display face of 20cm (8-inches) minimum, when display is powered.

CAUTION

Radar RF energy can be harmful to the eyes. **To reduce exposure to the risk of RF energy, do not stare into the radar antenna. Keep a minimum safe distance of 20cm (8-inches) from display face.**

2.5.4 Battery Safety

WARNING

Batteries may produce an explosive gas under some conditions. This gas may easily be ignited by a spark or flame as you work near the battery. To reduce this risk of explosion:

- Disconnect the battery**
- Work in a well-ventilated area**
- Avoid the use of devices that create sparks or use open flames**
- Use appropriate personal safety equipment and clothing**

9" Portable Value Driver Feedback Sign Installation Instructions

 WARNING

Battery acid may cause skin irritation and eye injury. **To reduce the risk of burns or other acid related injury resulting from handling lead-acid batteries:**

- Wear gloves, goggles, and an apron when handling batteries
- Beware of cracked battery cases
- Handle batteries with care.

 WARNING

To reduce the risk of burns or other acid-related injury resulting from exploding batteries:

- Always use the recommended charging systems with this product.

 WARNING

To reduce the risk associated with contamination of water supplies resulting from improper disposal of batteries containing lead and acid:

- Please dispose of batteries in accordance with all local government laws and regulations.

 CAUTION

An accidental short circuit may instantly heat conductive jewelry, tools, and surrounding objects to skin-searing temperatures.

To reduce this risk when working around batteries:

- Keep tools, jewelry, and other conductive objects away from the battery terminals.

2.5.5 Mechanical Safety

 WARNING

To reduce the risk of impact hazards resulting from falls, accident with a passing vehicle, and/or from unstable equipment:

- Use appropriate work zone traffic control methods, equipment, and procedures.

 CAUTION

Strain or back injury may result from lifting equipment improperly. **To reduce the risk of strain or back injury, use proper lifting techniques and have adequate help.**

 CAUTION

To avoid the possibility of injury due to falling or unstable equipment:

- Be certain the sign is mounted to an appropriately rated pole or equivalent mounting surface.
- Use appropriately rated mounting hardware.

 CAUTION

CAUTION: This sign is intended to be installed in accordance with the requirements of Article 600 of the National Electrical Code and/or other applicable local codes.

This includes proper grounding and bonding of the sign.

CAUTION

This equipment generates, uses, and can radiate radio frequency energy and, if not installed and used in accordance with the instruction manual, may cause harmful interference to radio communications. However, there is no guarantee that interference will not occur in a particular installation. If this equipment does cause harmful interference to radio or television reception, which can be determined by turning the equipment off or on, the user is encouraged to try to correct the interference by one or more of the following methods:

- Reorient or relocate the receiving antenna.
- Increase the separation between the equipment and the receiver.
- Connect the equipment on an outlet separate from that to which the receiver is connected.
- Consult an experienced radio/TV technician for help.

CAUTION: Changes or modifications not expressly approved by TrafficCalm could void the user's authority to operate the equipment!

2.5.6 Functional Safety**WARNING**

The beacon outputs of this display should not be used as the only means to notify drivers of speed limit changes in school or work zones.

- Use an approved safety device or signage to notify drivers of traffic zone changes that may affect the safety of pedestrians, workers, or drivers.

3 Description

TrafficCalm Driver Feedback Signs offer an innovative traffic calming solution to vehicle speed management problems. The Driver Feedback Sign (Figure 3-1) is a fully self-contained, numeric sign. The sign's LED display provides "real-time speed" to drivers within the sign's radar detection zone. If the vehicle speed exceeds the programmed speed limit, LEDs will flash to alert the driver of the speed violation.

Driver Feedback Signs present the driver with a highly visible display in the daytime or nighttime and under all weather conditions using high output LED's with photocell controlled automatic dimming. The automatic dimming provides the following benefits:

- Reduces power consumption and extends LED life
- Prevents "blooming" at night
- Provides excellent visibility in all conditions

The construction of the sign presents an easy installation with an environmentally protected electronics control system, which incorporates the battery power supply, that mounts onto the pole mount with two bolts and an optional lock (Figure 3-2).

The net effect is a driver feedback sign that is reliable and highly visible in all conditions. The Driver Feedback Sign in combination with a passive sign, which posts a regulatory speed, is an effective traffic calming tool designed to help reduce roadway speeds by enhancing a driver's speed awareness. Public safety is increased when roadway speeds are reduced.

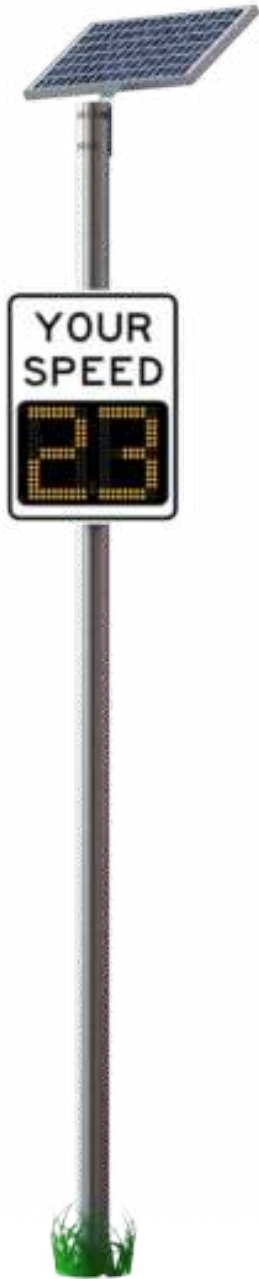

Figure 3-1. Driver Feedback Sign
Note: Solar panel not present on portable installations.



Figure 3-2. Easy Removal

3.1 9SE DFB Sign Specifications

Electrical

AC Charger

Maximum input Wattage: 60W

Maximum Output: 14.6VDC

Temperature compensated and protected

Operating Environment

Temperature range: -34°C to +74°C Ambient
29.2°F to +165.2°F

Humidity: 95% Non-condensing

Radar

Frequency: K-band (24.125 GHz)

Cone of View: 30 deg

Detection range: approx. 400 ft (+400/-100)

Sign Size

18 inches wide

24 inches high

1.75 inches thick

Sign Weight

20 lbs

Communications

IR Remote

Configurable Parameters Using IR Remote

- Below minimum - blank display
- At speed limit +1 - blinking display (2Hz cycle)
- At speed limit +4 – increasing blinking display (three increments up to 5hz at speed limit +12)
- Above maximum speed – blank display
- Radar squelch (sensitivity)
- Units (MPH/KPH)
- Brightness offset
- Security PASSKEY (5-Digits)
- Simple, 24hr On/Off schedule
- Schedule Delay

3.2 9SE Portable Power Kit

The Portable Driver Feedback Sign has the following power options.

AC Charging Adapter

The AC Charging adapter is not approved for outdoor use, do not expose the adapter to rain, moisture, or other dangers that may risk damage to the charger and/or sign. It is recommended that the sign be allowed to charge overnight; charge time from empty will take approx. 6 hours. The AC adapter is designed to optimize battery capacity and charging; it will not overcharge and prevents damage to the internal battery. The included adapter is intended for use with the sign it is supplied with, do not use to charge a 12” portable display; as this may not fully charge the display. Conversely, a charge adapter intended for use on a 12” sign could cause damage to the battery in a 9” sign in a fault condition.

The charger plug is internally fused to prevent a catastrophic failure of the battery harness in the event the plug is shorted.

Table 3-1 AC Charging Adapter Specification

Dimensions (Inches) Width, Height, Depth	8"x8"x6"
Weight (lbs/kgs)	12lbs (5.5kgs)
Input Voltage (VAC)	100-120 VAC
Nominal Output Voltage (VDC)	18.5 VDC
Output Rated Current (Amps)	3.2 Amps

Table 3-2 Internal Battery Specification

Type	NiMH
20 Hr Rate (AH)	20

4 Pre-Installation

The 9SE Driver Feedback Sign should be installed on roadway sections that provide the most benefit to the public. Once an installation site has been selected, it should be verified with a site survey.

Also, prior to installation, the sign should be tested to verify that the sign’s electrical components are functioning properly and that the sign was not damaged during shipping.

If any of the tests performed fail, refer to the troubleshooting section of this manual to diagnose the problem.

4.1 Site Survey

Before installing the Driver Feedback Sign, an installation site must be selected. It is very important to select a site with the following characteristics:

There must be a clear view of the sign from the roadway for at least 500 feet and, the viewing area must be clear of trees. Attenuation of the radar's signal, caused by trees, may reduce the radar's effective range.

Do not install the sign facing an intersection or bridge if possible. If the sign must be installed facing an intersection or bridge, the sign should be located at least 400 feet away. Cross-traffic may be registered by the radar as an oncoming vehicle.

The sign should be located at least 200 feet away from large street signs that fall within the radar's detection zone and cause the radar to reflect its' output. Reflecting the radar's output by objects such as signs may cause vehicles to be detected in the opposite direction.

Install sign in roadway geometries that allow clear view of the sign's display and provide the most efficient radar detection zone.

Proper site selection will provide the greatest traffic calming effect and sign performance.

4.2 Pole Selection

Pole selection for the Driver Feedback Sign is an important element in the installation design. Poles selected for mounting the DFB must support the weight and wind loading of the sign, power option and any static signs. Crash worthiness may also need to be considered. Use a break-away pole and attach the display using a 3 point bolt structure to improve crash worthiness.

Based on a wind load of 29 pounds per square foot, the sign wind load is 87 pounds. Based on an ice load of 3 pounds per square foot on all surfaces and dead load the max sign weight is 37 pounds. This is based on a max wind of 90 mph with an exposure category of C reference the International Building Code. For different wind and ice conditions, consult a local engineer. Supply mounting hardware and poles adequate for the loads. If using bands, do not over-tension.

After a storm approaching or exceeding 90 mph winds, inspect the sign and mounting for damage and replace or repair as required.

In mounting the sign use a minimum of 2 bands centered on the back mounting bracket or a minimum of 3 each, 3/8" bolts with flat washers and other mounting hardware as required.

4.3 Mounting Bracket

The 9se Driver Feedback Sign is provided with mounting provision at the back of the sign. The mounting provision is designed to be banded and/or anchored/bolted to the mounting structure. Anchoring and bolting is recommended over banding to improve performance in areas where high wind is normally expected and for increased crash integrity capability. Listed below is some additional mounting hardware that may be used to mount the sign to a pole:

Preferred method:

- Pelco Bands, P/N: US-8124-06
- Pelco Banding Buckles, P/N: US-8124-56
- Tools Needed: Pelco P/N: US-8120-01 and US-8120-06 handle.

Another option is the EZ-Band Kit P/N US-8500 (one per band) with US-8122-06 banding, or US-8504 with US-8124-62 banding. Standard tools can be used to tension these; however they are not as secure since standard tools can also remove them.

- Pelco can be contacted at 1 (405) 340-3434 for product and ordering information.

4.4 Sign Test Procedure

Remove the service access panel and move the red wire to the 12+VDC location on the terminal block. Replace the service panel.

Connect the sign to the supplied charger and allow to charge overnight.

Verify that the display and display controller are functioning correctly.

Using the supplied IR remote place the sign in test mode (see section 5.2.5)

The sign then cycles through its test character set until the sign is taken out of test mode using the remote

Visually verify display functionality. If the sign fails, refer to the Troubleshooting section of this manual for help.

Turn on the display with the included remote (see section 5.2). The sign enters its normal mode of operation. Note: The manufacturer setting powers up with the radar on.

Deploy the sign to a desired location. Place the sign in a location where vehicles are approaching the sign within the range of the radar.

Visually verify that the sign is displaying a speed value approximately equal to that of the approaching vehicles.

4.4.1 Expected Sign Behavior

The table below (Table 4-1) details the expected operating behavior of a DFB's scheduled ON/OFF states. SPEED represents the state where a DFB is measuring and displaying vehicle speeds. BLANK represents the state where no vehicles are approaching the sign or the sign is in the scheduled OFF state.

Table 4-1. DFB Operation Behavior

TIMED DISPLAY STATUS	Vehicle Present	No Vehicle Present
ON	SPEED	BLANK
OFF	BLANK	BLANK
NON TIMED		
DISPLAY OFF	BLANK	BLANK
DISPLAY ON	SPEED	BLANK

4.4.2 Expected Charging Behavior

The charger requires at least 6 hours to place a full charge on the battery. Upon initial installation, the battery must be charged to at least 11.5V; below this the sign will not initialize and will be unresponsive. The battery must be charged to at least 12.1V for the sign to turn on in radar mode. Also, the battery must be charged to at least 12.8V to recover from a low voltage shut down.

At ~12.25V the display will dim (if possible)

At ~12.05V the sign will dim the display further (if possible), adjust the lowest speed setting higher (to display less feedback), and adjust the squelch to "50" (to reduce range).

At ~11.84V the sign will adjust the squelch to "80" to further reduce the range.

At ~11.45V the display will enter a power-down mode (display will not show feedback), but remote communication will still be available

At ~11.2V the sign will initiate sleep mode and will become unresponsive. Clock setting will be lost and all schedules will be cancelled (will require reprogramming, see section 5.2).

5 Installation

This section contains installation procedures for a Driver Feedback Sign (DFB). The 9SE DFB includes the required charger and hardware for most installations.

CAUTION

CAUTION: This sign is intended to be installed in accordance with the requirements of Article 600 of the National Electrical Code and/or other applicable local codes.

This includes proper grounding and bonding of the sign.

5.1 Sign Installation

Attach the mounting bracket to a suitable pole or structure.

The bottom of the sign should be about 7 feet above the ground as shown in Figure 5-1. Aim and band or bolt the sign to the pole.

Assemble the DFB sign (A) to mounting bracket (B) as shown in Figure 5-2. Be careful to keep fingers clear of the brackets as they come together since they may form a pinch point. **Do not over-tighten the 2 mounting bolts (C).** They act as a pin, and are not intended to compress the mounting bracket. Take care when handling the edges of the sign and bracket, especially when attaching the sign onto the bracket.

WARNING

Pinch Points.

Moving part can crush or cut.

KEEP CLEAR.



Figure 5-1. Typical DFB Mounting

(Solar Panel not present on portable installations)

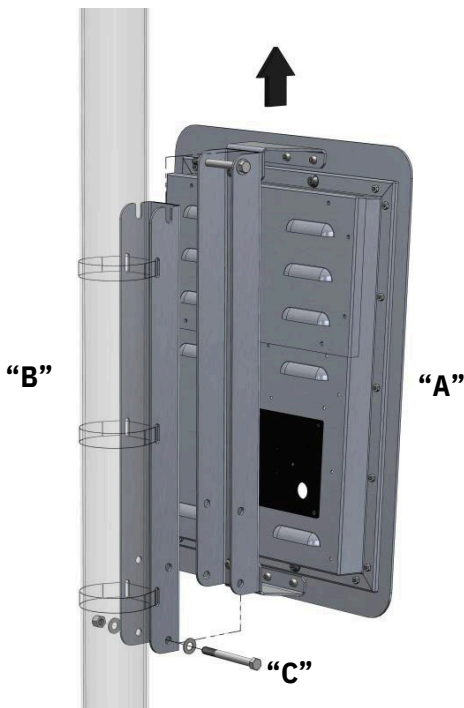

Figure 5-2. Connecting DFB Sign to Bracket

The sign is securable with two locking mechanisms. The first is a padlock at the bottom hole of the mounting bracket. To use a padlock, place bolt “C” in the upper location and fasten the padlock as seen

in figure 5-3. The second is with a readily available trailer “barbell” lock as seen in figure 5-4

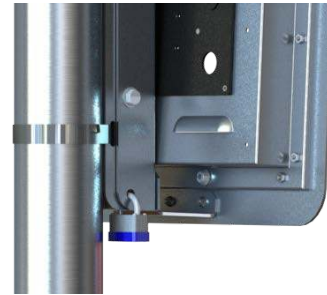

Figure 5-3. Securing Sign with Padlock

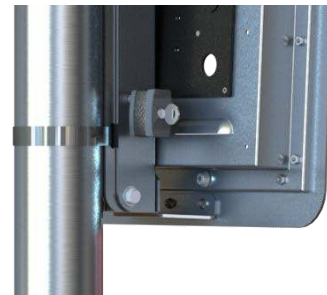

Figure 5-4. Securing Sign with “Barbell” Lock

5.1.1 Aiming the Sign

The 9SE DFB contains an internally mounted radar speed detector to detect on-coming vehicle speed. The radar requires that the face of this sign be aimed, allowing the radar to accurately detect vehicles. For best operation, the face of the sign should point into traffic as close to parallel with the direction of traffic flow as possible. For best accuracy, the angle of incidence should be 5 degrees or less. Angles of incidence greater than 10 degrees will display slower than actual vehicle speed. For best range try not to aim the sign so that the lanes of receding traffic are in the radar detection area.

5.1.2 Sign Radar Operation

The sign’s radar continually emits weak levels of microwave energy at a specific frequency (K-band, 24.15 GHz) and scans for returns from moving objects. When this microwave energy encounters an object, some of the energy is reflected back to the radar. If the object is moving, the frequency of the reflected microwaves is changed by an amount proportional to the relative speed of the moving object. This characteristic frequency change is known as “Doppler Effect.” The radar unit measures the difference between the frequency of transmitted energy and the frequency of the reflected energy to

determine the relative velocity of the moving object. Ensure that the following items are taken into consideration when choosing an installation site for the sign:

The sign may display speeds of vehicles traveling perpendicular to the sign's face. Ensure that the sign is not installed within 400 feet of an intersection, bridge, or similar roadway feature.

Obstructions such as a static sign, building, inclination, or similar factors may influence the distance range of the vehicle detection and the accuracy of the displayed speed values.

The radar needs to have a clear view of the targeted vehicles. Avoid mounting the sign behind trees, poles, tall parked vehicles, and so on.

The system should not be used in the range of road turns and bends. This may result in the sign displaying speeds that are lower than the actual speed of the object.

5.1.3 Radar Properties

The distance range of all microwave detectors depends to a large extent on reflection properties of the measured objects and interference properties of the nearby surrounding objects.

The following properties can be expected:

Vehicles that appear larger and flatter to the microwave beam axis provide a longer radar detection range.

A less absorbing and scattering reflective surface results in a longer detection range.

As more objects obscure the radar measurement beam, the detection zone will become shorter (diffraction scattering, foliage losses, shadow losses, and so on).

The following factors have a reducing effect on the distance range:

Buildings, trees, poles, parked cars and containers, which hamper the "free sight" of the radar detector and may lead to shorter ranges.

Influence by weather, rain and snow lead to absorption losses at the radar detector.

"Blinding of the Radar" by stationary traffic in the radar beam, or extraneous moving objects like branches of trees, birds and so on.

Depending upon vehicle type and reflective properties, the typical passenger car will have a detection range of 400 feet for the 9SE DFB. For trucks, the distance range is about 50% to 100% longer due to the larger reflective surface. For motorcycles, distance range is reduced by 50%.

The above mentioned detection distance limits are not a limitation of the radar itself, but the optimal viewing distance of the driver. We reduced the radar's detection range so that the driver can view his/her speed clearly while approaching the sign. The optimum distance range has a sign mounted at a height of 7 feet from grade to the sign's housing bottom.

5.1.4 Measurement Angle

The angle between detector beam axis and the movement axis of the detected vehicle (see Figure 6-3) has direct impact on the measured speed. This is expressed by following formula:

$$V_{\text{measure}} = V_{\text{absolute}} \times \cos \phi$$

with ϕ : measuring angle

The ideal measurement angle is 0° , this means

$V_{\text{measure}} = V_{\text{absolute}}$ and movement axis and radar beam axis are identical in this case.

IMPORTANT

The error in the speed values will become greater as the measurement angle increases.

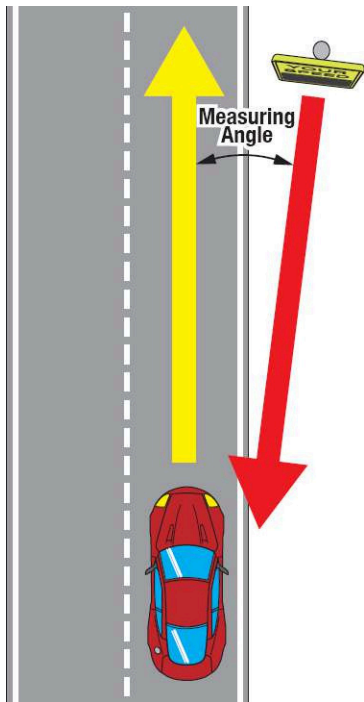

Figure 5-5. Radar Speed Errors

5.1.5 Wiring Instructions

In addition to these instructions use best practices as prescribed by the NEC. These instructions should only be carried out by a qualified technician.

The 9SE Portable features an external connection to the charging adapter.

Connecting the Sign to charging adapter (See Figure 5-6 and 5-7):

1. Remove the service access panel and move the red wire to the 12+VDC location on the terminal block. Replace the service panel.
2. Ensure a working fuse is installed in the externally accessible fuse holder.
3. Plug the charging adapter into the sign; ensure the adapter is screwed onto the
4. mounting hole for guaranteed connection. Allow the sign to charge for at least 6 hours



Figure 5-6
9SE Service Panel Access

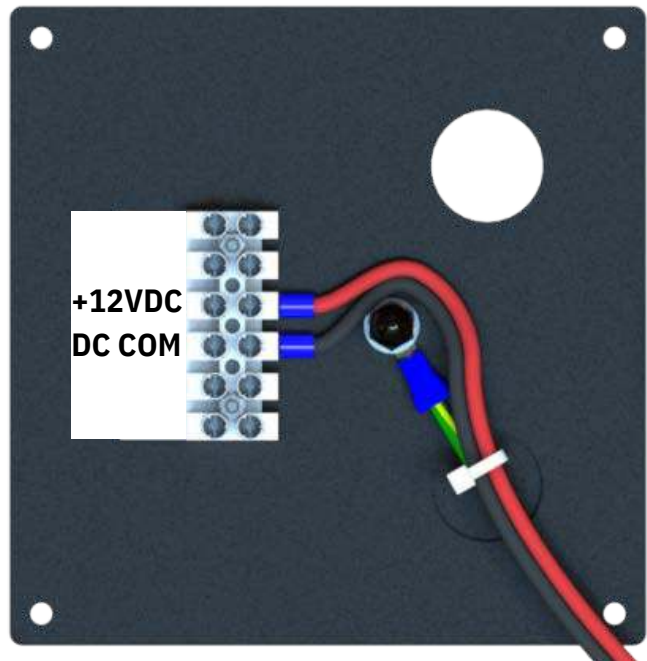

Figure 5-7
9SE DFB Wiring

9" Portable Value Driver Feedback Sign Installation Instructions

5.2 Powering on and Programming Sign

Follow these steps for programming the user definable options of the SE sign. Each step shows the user's button press (or action), followed by the expected status LED response and the default display response (if any).

Note that when the sign is in "RADAR ON" mode the 5th status LED will blink about every 3 seconds, when the sign is in "STANDBY" mode the 5th status LED will blink intermittently, about once every 15 seconds.

After you have made the desired changes, press "EXIT" to finalize.

If, at any point, you get lost in the setup process, press "EXIT" to start over; passkey entry will be required. After entering the passkey the sign will remain "unlocked" for 20 minutes or until the "EXIT" button is pressed.

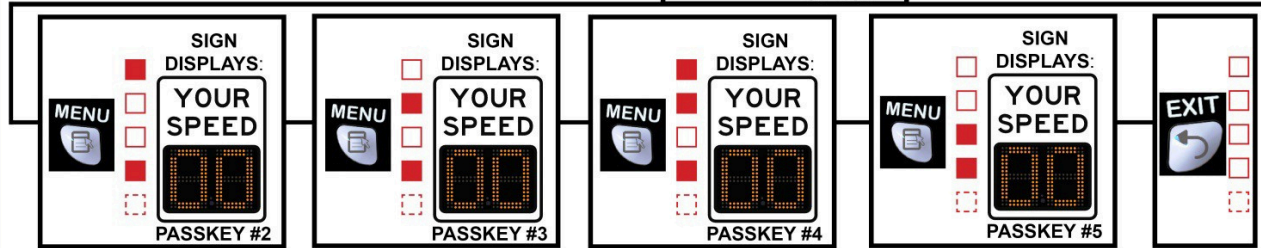
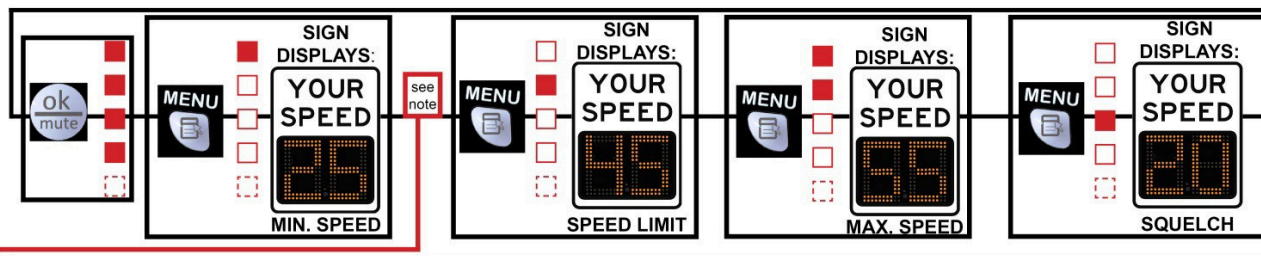
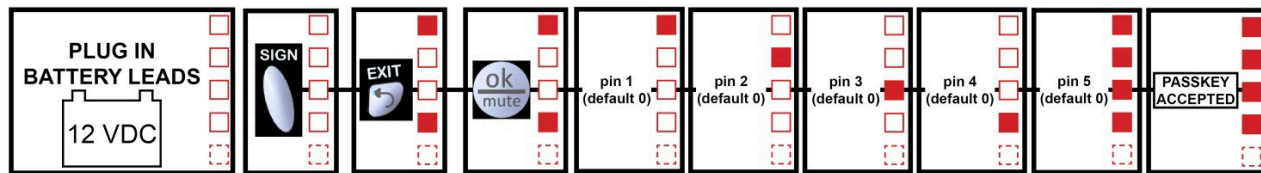

TO ADJUST ANY MENU OPTION:

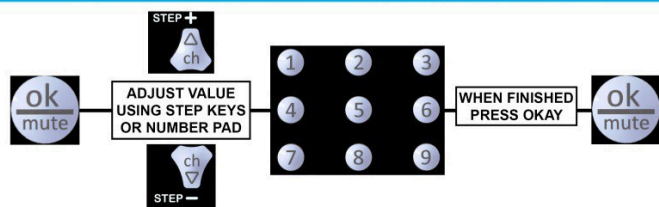

TO TURN SIGN TO ON/STANDBY:

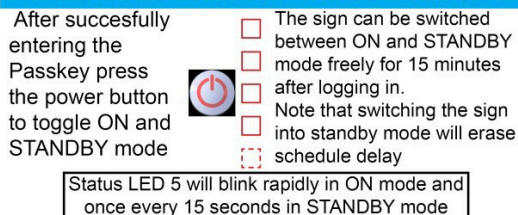

TO TURN SIGN TO TEST/DEMO

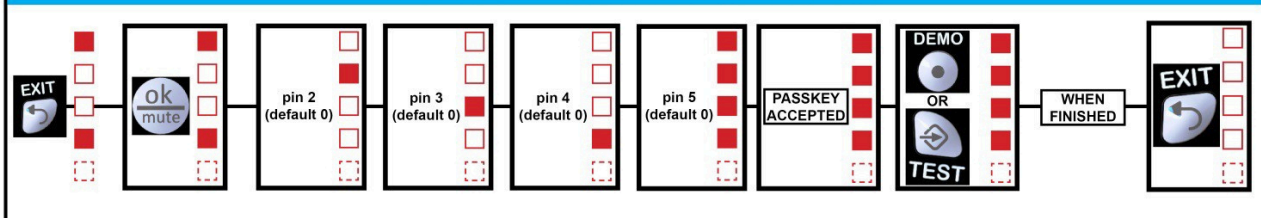

5.2.1 Powering on and Programming Sign

The sign features 5 discrete status LEDs in the 10's digit; the bottom LED reports sign status and the top 4 report various programming functions; See Appendix C for LED sequence key. Before programming the sign consider the following:

1. Ensure the included remote has 2 charged AAA batteries installed correctly. If the batteries have been replaced, the remote may need to be reprogrammed. To do so press "Sign," then press  and hold the button until the remote's single LED illuminates and stays lit. Enter the **code 1221**, the LED will extinguish, and the remote will be ready to use
2. The remote operates within approx. 5 to 20 feet from the face of the sign (range may be affected by the presence of bright light or fluorescent lamps)
3. If the remote is unresponsive, press the "SIGN" button
4. The sign is programmed from the factory with the passkey set to 00000. When an action requires the passkey to be entered, the 1st and 4th status led will illuminate
5. If, at any point, you get lost in the programming process, press the "Exit" button on the remote to start over, passkey re-entry will be required

5.2.2 Speed Settings

The sign is shipped from the manufacturer with a default speed configuration of 15, 25, and 50 MPH. These values will need to be adjusted to suit the installation.

The three speed thresholds determine what is displayed to the driver as they approach the sign. The first setting is the lowest speed that will be displayed; below this the sign will be blank. The second is the actual speed limit at the location; above this the sign will blink the driver's speed at incremental rates to promote driver calming. The third is the maximum speed the sign will display; above this the sign will be blank to prevent sign "racing."

5.2.3 Squelch Adjustment

Adjusting the squelch will allow you to fine tune the radar's sensitivity. The default value is 20. This is a suitable setting for most installations. A lower squelch will increase the sensitivity, though too low may result in false readings. A higher squelch will decrease the sensitivity. Setting the squelch higher can resolve some site specific false interference, though setting it too high will result in reduced range.

5.2.4 Setting Units

By default the sign is programmed to measure in MPH. You can adjust the sign to measure in either MPH or KPH with this setting. Set the value to 00 if MPH is desired or 01 if KPH is desired.

5.2.5 Setting Brightness Adjustment

The 9SE sign features an onboard light sensor which adjusts the brightness of the display automatically. The automatic adjustment can be offset more or less by setting the brightness option. The sign will continue to automatically adjust for ambient light, but will reflect the adjustment. From the manufacturer the sign is set to a brightness of 16. Any value below 16 will be dimmer, which can extend autonomous operation during long periods of low exposure but reduce visibility in daylight. A value above 16 will be brighter, but this will increase power consumption and may be too bright in darkness.

5.2.6 Setting Start-Up Option

This setting selects what happens when the sign is powered on. Setting to 0 will cause the sign to be in standby mode when powered on. Setting to 1 will cause the sign to be radar mode when powered on.

5.2.7 Setting a Security Passkey

The default **passkey is set to 00000**. This 5-digit passkey can be overwritten in the menu for added security. If you create a passkey, write it down in an easily found location. ***Once the passkey is set it cannot be unset or overridden without returning the sign to the manufacturer!***

Note that after 20 minutes of inactivity the sign will require the passkey to be entered again. If the status LEDs appear to be acting unexpectedly, the sign may be experiencing IR

interference. A passkey can be set to lock out the interference and allow for normal operation.

5.2.8 Programming Timed Operation

The sign can be configured with a simple 24-hour schedule. The sign can be scheduled to turn on then off twice a day and run for a specified duration following each on-time. To set the daily schedule:

1. With the sign in “Standby” mode, press “STEP +” or “STEP-” on the direction pad to select the hours of delay until the first run time begins; during this time the sign will be off; if no delay is desired select “00”. Next, press “VOL +” or “VOL -” on the direction pad to select hours of time the sign will run for following the delay. If a second run time is desired, press “OK,” then press “STEP +” or “STEP-” on the direction pad to select the hours of intermission until the second run time begins; again, the sign will be off during this time. Next, press “VOL +” or “VOL -” on the direction pad to select hours of time the sign will run for following the intermission. When finished press “EXIT.” The sign will repeat this schedule every 24 hours.
2. Note that the schedule will be erased if either the sign is switched from STANDBY mode to ON mode or if the sign loses power in the event of a depleted battery.
3. For example:
 - a. An SE sign in a school zone should be active from 7:30 to 9:30 and 13:30 to 15:30 (an hour preceding and following the start and close of the school).
 - b. To be able to set this schedule the sign will need to be programmed when the clock strikes the half hour.
 - c. At 18:30, set the sign to delay 13 hours (the sign will turn on at 7:30 the following morning), and to run for 2 hours (the sign will turn off at 9:30). Press “OK.” Set the intermission to 4 hours (the sign will turn on at 13:30) and set the run time to 2 hours (the sign will turn off at 15:30). This pattern will then repeat every 24 hours daily.

5.2.9 Display Test and Demo

The sign has two tools to confirm proper operation.

1. To test display functionality press the “TEST” button on the remote. The sign will run through all 10 digits (0-9) on the right side of the display, then all 10 digits on the left side. Visually observe the sign for full functionality.
2. To test your current speed configuration press the “DEMO” button on the remote. The sign will now sequence through a set of numbers that reflect your set speed ranges. Visually observe the behavior of the sign to ensure expected operation.



Figure 5-8 Included 9SE Remote

For Additional training tools, please visit us at:

trafficalm.com/resources/value-sign-simulator

Value Sign Simulator is a virtual training tool designed to help technicians program and operate Radar Speed Value Signs. This web-based tool streamlines the learning process, enabling both pre-programming and on-site adjustments with the included remote control.

6 Troubleshooting

This section provides troubleshooting information intended for use by technicians who are familiar with this type of variable message sign. The right knowledge combined with a systematic approach to the problem will result in an efficient and timely repair. Once the problem is identified, analyze why the failure occurred. If a maintenance issue led to the failure, include it in the next preventive maintenance trip to all of the signs. If a fuse blew, find out why instead of just replacing fuse after fuse. One small problem may be an indication of a larger problem about to happen. Fix problems before they happen whenever you can.

To use this guide, start at the beginning of the troubleshooting table (see Section 6.1). Each observation listed in the table describes a basic problem that a user might encounter and suggests a course of action. In some cases, the course of action is to look at another section of the table. The situations start out general and get more detailed as progress is made. Once a description of the problem is found that most closely matches what you observe, follow it to its logical conclusion in the “Cause/Action” table.

The first step in troubleshooting is to clearly define the problem.
Here are just a few examples:

- *Is the problem intermittent or continuous?*
- *Is the problem present only in the operation mode or, does it also occur in the test mode?*

If needed, technical assistance is available by contacting your local partner or TrafficCalm Technical Service department at 1-855-738-2722. Technical service hours: 7:00 A.M. – 5:00 P.M. Pacific Standard Time, Monday through Thursday and 7:00AM to 12:00PM PST on Friday.

6.1 General Troubleshooting

Observation	Possible Causes	Solutions/Action	Reference
Sign is non-functional – Can't connect with Remote	No power to Sign	<ul style="list-style-type: none"> Check power (Look behind front face through masked left digit segment openings to see if any red lights are on) - Restore Power to Sign 	See Section 5.1.5
	Sign has Shut down and is sleeping due to very low voltage	<ul style="list-style-type: none"> Check voltage to sign – Diagnostic Red LED's may be lit or may flash periodically. Volts applied to sign less than 10.5V - Restore proper voltage to the sign. 	See Section 5.1.5
	Sign is configured OFF	<ul style="list-style-type: none"> Cycle power to the display and check for remote connectivity If sign never responds to remote the sign must be replaced. 	See Section 5.2
	Remote batteries are dead (See also "Cannot communicate to sign")	<ul style="list-style-type: none"> Test remote function using known good AAA batteries 	See Section 5.2
	"AUX 1" button or "AUX 2" button has been pressed on remote	<ul style="list-style-type: none"> Press "Sign" 	See Section 5.2
Status LEDs light unexpectedly and remote has difficulty making changes	IR interference	<ul style="list-style-type: none"> Set a PASSKEY in the MENU settings to lock out interference source. 	See Section 5.2.6
Sign is non-functional – Connection with remote is possible	Sign scheduled OFF	<ul style="list-style-type: none"> Using the remote, power the sign off and then on again to clear unintended schedule. 	See Section 5.2.7
	Display disabled	<ul style="list-style-type: none"> Verify that sign is supposed to be enabled. Enable the display using the remote 	See Section 5.2
	Sign has shut down due to temperature or low voltage (Not Sleeping)	<ul style="list-style-type: none"> Use multi-meter to check battery voltage. Operating temperature: $-50^{\circ}\text{C} < \text{Sign} < +80^{\circ}\text{C}$ Operating Voltage from battery: $12.3\text{V} < \text{Sign} < 16\text{V}$ Sign will resume operation when conditions return to normal levels. 	See Section 3.1
	Failed Electronic Control System	<ul style="list-style-type: none"> Verify Sign has proper voltage and current available. Verify sign is properly configured (and scheduled*). Replace sign if needed. <p>*Schedules are not necessary to make the sign run, but they can prevent it from running.</p>	See Section 5
	Sign is in Log-In mode	<ul style="list-style-type: none"> If status LEDs 1 and 4 are illuminated Passkey entry is required. Press okay and enter the 5 digit passkey (00000 if unchanged from default setting). If custom passkey is unknown, the sign must be returned to the manufacturer to be reset. 	See Section 5.2

6.1 General Troubleshooting

Troubleshooting

Observation	Possible Causes	Solutions/Action	Reference
Cannot communicate with the sign	No power to sign	<ul style="list-style-type: none"> Check power connection to sign and verify operation. 	See Section 5.1.5
	Remote batteries are dead	<ul style="list-style-type: none"> Ensure batteries in remote are fresh and functional 	See Section 5.2
	Display is out of range.	<ul style="list-style-type: none"> Contact technical service at (855) 738-2722. 	See Section 5.2
The sign is not detecting cars as expected	Sign is not aimed properly	<ul style="list-style-type: none"> Re-aim the sign while taking into account a 30 degree radar beam width to cover the approaching lane of travel at the required distance. Re-aim the radar beam width for least spill-over into the opposing lane of travel. 	See Section 5.1.1
	The radar signal is being reflected	<ul style="list-style-type: none"> Ensure that there are no large static signs or other obstructions within 200 feet of the sign face. 	See Section 5.1.1 for aiming and Section 5 for pre-installation requirements
	Sign speed settings are interfering	<ul style="list-style-type: none"> Double check sign configuration matches expected behavior. 	See Section 5.1.6
	Low Range: Squelch adjustment too high Phantom targets: Squelch adjustment too low	<ul style="list-style-type: none"> Readjust Squelch to get desired noise rejection and range. 	See Section 5.1.6
	Other Hardware Malfunction	<ul style="list-style-type: none"> Contact technical service at (855) 738-2722. 	
The sign is displaying speeds of vehicles traveling away from the sign	The radar signal is being reflected in a way that causes the sign to register the speed of vehicles traveling away from the sign	<ul style="list-style-type: none"> Ensure that there are no large static signs or other obstructions within 200 feet of the sign face. These objects can reflect the radar signal, causing the sign to register the speed of vehicles traveling away from the sign. 	See Section 4 for preinstallation requirements
	Long range signal to noise ratio too low.	<ul style="list-style-type: none"> Weak signal targets at limit of range may not resolve direction properly causing display hold time to show the speed of a misread target. Adjust Squelch higher to reject weaker signals or adjust aim of display to strengthen signal or reduce noise. 	
	Display malfunction	<ul style="list-style-type: none"> Contact technical service at (855) 738-2722. 	
The sign is displaying unexpected speeds of oncoming vehicles near an intersection	The radar signal is measuring cross traffic	<ul style="list-style-type: none"> Cross traffic can register as oncoming vehicles to the radar. Ensure that the sign is located at least 400 feet from an intersection Adjust "Squelch" to suppress noise from cross traffic and reflections. 	See Section 4 for preinstallation requirements

6.1 General Troubleshooting

Observation	Possible Causes	Solutions/Action	Reference
Display has no power	Low battery	<ul style="list-style-type: none"> • Too much load for available power: reschedule the display operating times, display brightness, etc. to conform to available sunlight. • Charger Failure: Test for proper operation and replace if needed (see device operator manual from manufacturer) • Battery Failure due to age, temperature, or abuse: Replace Batteries after fixing abusive conditions. 	
	Battery Charger Kit:		
	Fuse Opened	<ul style="list-style-type: none"> • Check wiring, connectors and display for damage that may cause short circuit, then replace fuse with same type and rating. 	See Section 5.1.5
	Bad Connection to Display	<ul style="list-style-type: none"> • Check connections between display and power source and repair as needed. 	See Section 5.1.5



TraffiCalm Systems provides the following warranty for its traffic calming solutions whether sold directly by TraffiCalm or by an authorized TraffiCalm distribution partner.

- TraffiCalm Systems warrants the product, excluding batteries, will be free of defect in materials and workmanship for a period of three (3) years beginning on the day the end user receives the product. Warranty is only valid if the product is ineffective for its intended purpose due to defects in materials or workmanship
- Warranty is only valid if the product is installed, operated and maintained in accordance with the manufacturer's instructions and recommendations (available upon request).
- TraffiCalm's sole responsibility, and the purchaser's and users' exclusive remedy, shall be that TraffiCalm will either repair or furnish replacements for defective parts.
- Replacement parts will carry the unexpired warranty of the parts they replace. Any repairs conducted on out-of-warranty items will carry a 90 day warranty.
- Claims made under this warranty will be honored only if TraffiCalm is notified of a failure within the warranty period, reasonable information requested by TraffiCalm is provided, and TraffiCalm is permitted to verify the cause of the failure.
- TraffiCalm assumes no liability for any incidental or consequential damages, in any way related to the product regardless of the legal theory on which the claim is based.

This warranty does not cover damage resulting from:

- o Accidents, vandalism, impact with a foreign object, or acts of God.
- o Product modifications made by someone not authorized by TraffiCalm
- o Failure of Customer to follow TraffiCalm's published operating instructions
- o Failure to follow TraffiCalm's published site selection and installation instructions
- o Removal or relocation of the unit,
- o Electrical work external to the unit, virus/hacker activity, and external computer errors.

THIS WARRANTY IS MADE IN LIEU OF ALL OTHER WARRANTIES AND CONDITIONS, EXPRESS OR IMPLIED, INCLUDING BUT NOT LIMITED TO THE IMPLIED WARRANTIES AND CONDITIONS OF MERCHANTABILITY.

Appendix A: 9SE DFB Drawing

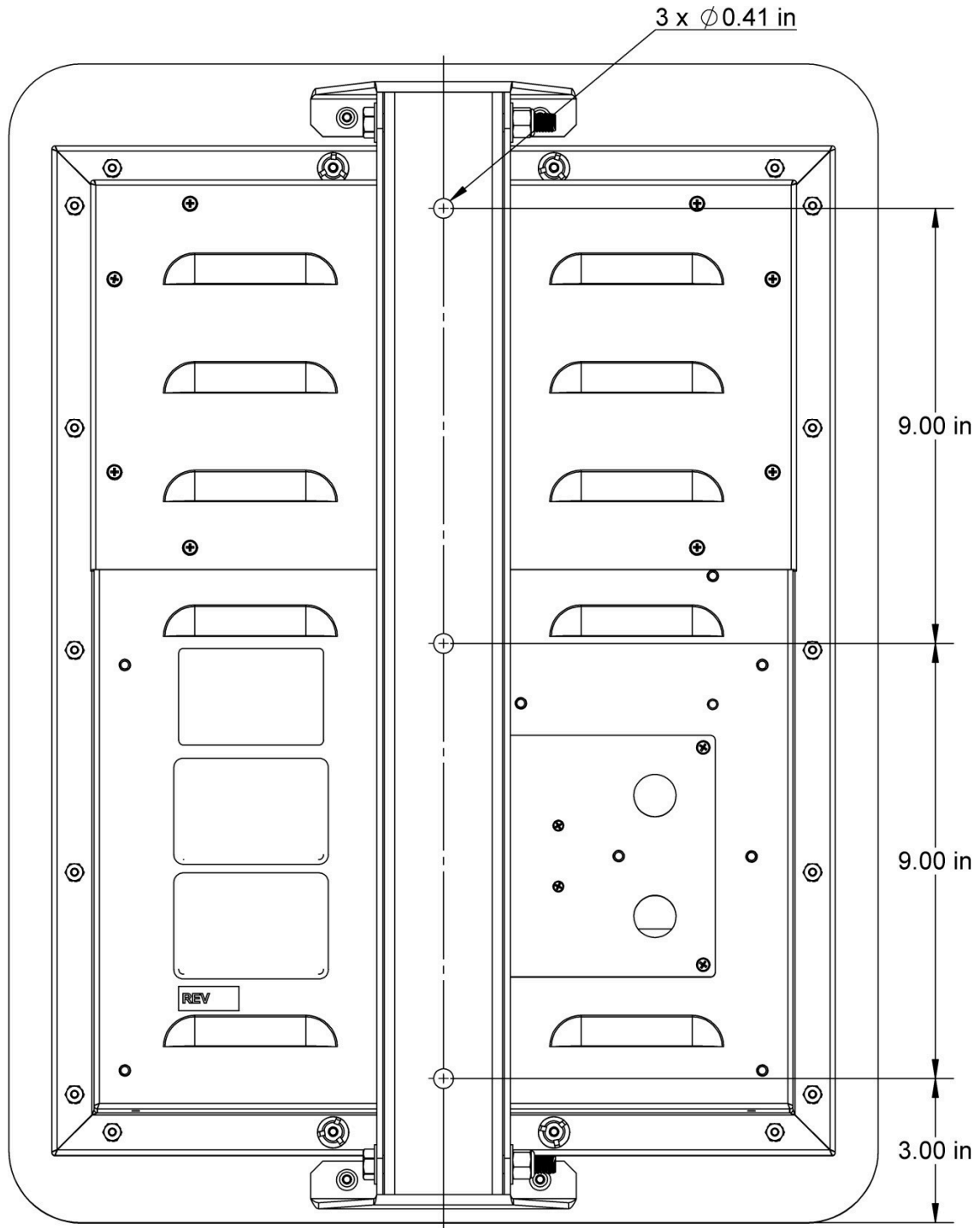

BACK OF SIGN
MOUNTING HOLE PATTERN

Appendix C: Status LED Key

Status LED(s) Illuminated	Message
1	1st digit of PASSKEY has been entered Or 1st menu setting (MIN Speed) currently selected
2	2nd digit of PASSKEY has been entered Or 2nd menu setting (Speed Limit) currently selected
3	3rd digit of PASSKEY has been entered Or 4th menu setting (Squelch) currently selected
4	4th digit of PASSKEY has been entered Or 8th menu setting (PASSKEY Digit) currently selected
5 Rapid Blink	Sign is ON in RADAR mode
5 Periodic Blink	Sign is in Standby mode, power is applied
1, 2	3rd menu setting (MAX Speed) currently selected
1, 3	5th menu setting (MPH/KPH Units) currently selected
1, 4	Passkey input required Or 9th menu setting (PASSKEY Digit) currently selected
2, 3	6th menu setting (Brightness Offset) currently selected
2, 4	10th menu setting (PASSKEY Digit) currently selected
3, 4	12th menu setting (PASSKEY Digit) currently selected
1, 2, 3	7th menu setting (Memory State) currently selected
1, 2, 4	11th menu setting (PASSKEY Digit) currently selected
1, 2, 3, 4	No PASSKEY has been set, sign is ready to program



TRAFFICALM

For Any Further Assistance Please Call
our Technical Service Department at:
855-738-2722

Revision	Reason	Owner/Date
A	Original Release	xx-20140730
B	Name Change Only	xx-20170511
C	Minor Changes	xx-xxxxxxx
D	Updated Warranty Statement	AP-20190807
E	Style Revision, Updated information, Added pages	DS-20240507